



YLI ELECTRONIC

Tappet Contact

Model:DLK-404



Basic Instruction

Door loop is made of excellent material,Seiko quality,Special design,Applicable to use for access control,to protect the wire when install the elctric lock,magnetic contact,alarm button on the door, convenient and beautiful.

Specification

Material Selection: High Strength Aluminum, Sandblast Finished

Suitable for Door: All Kind of Single Door & Double Doors

Max. Current: 5A

Max. Voltage: 0-36VDC/VAC

Contact Material: Plated brass

Weight: 0.06kg

Dimension

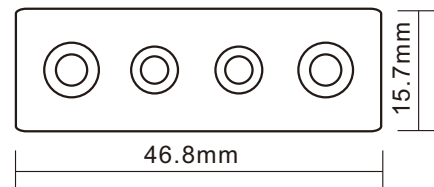
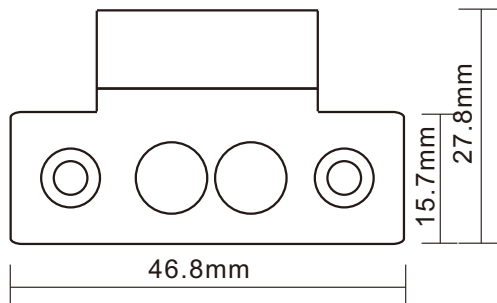

Installation

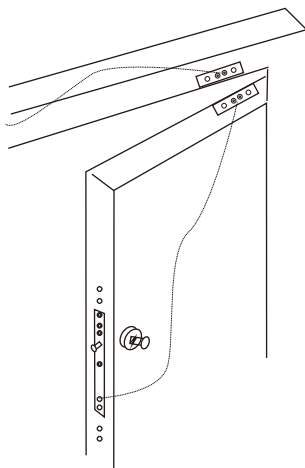

Feature

Select the Special Durable Material

Link on the Door Leaf and Door Frame Without Wires

Convenient for Special Installation

Speciality Use for the Access Control Project