

KCV-544SD/D544SD MANUAL

[7" Digital Color LCD Videodoorphone]

AHD MEMORY COLOR HANDSFREE Video Phone

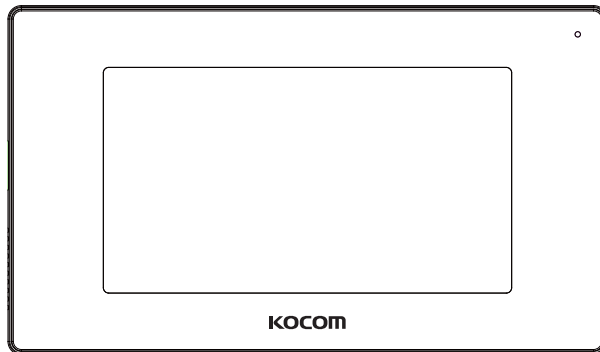

- 7" Digital LCD Screen (NTSC/PAL)
- Customer-customized UI/Full Touch Screen
- Compatible with 1080p(FHD) AHD CCTV (TVI , AHD , CVI)
- CCTV Motion Detection / Recording function(1080P)
- Compatible with SDXC 128GB(MAX) Micro SD CARD
- Auto Video Recording(Door Camera)
- e-Album (includes music function)
- Connection up to 2 Door Cameras and 2 Monitors with Sub-interphone (KIP-32G)
- Internal Communication between indoor units
- Multifamily, Apartment Application (KLP-C420 SYSTEM)

Cautions for safety







For safe use, please stick to the following cautions.

- Please do not dispose this manual after reading the instructions carefully.
- Please read all instructions to set up rightly.
- This Cautions for Safety may include items that are not contained in specifications of the product that consumer purchases.

The important marks in the manual.



To help our customers to understand this manual, to prevent any personal injury or property damage, some marks are used in the manual. The marks and the drawing signs are below. Please, understand the marks before reading the manual.

The meaning of the drawing signs.



 Sign to show what not to do.	 Mishandling the device with ignoring this sign may result in serious injury or death.
 Mishandling the device with ignoring this sign may result physical injury or material damage.	
 Sign to tell you that you should follow the instructions.	 Sign to tell you that you must unplug the unit.
 Sign to tell you that you can't disassemble this unit.	

Caution

Cautions for set-up



- The law limits distributing the power wire to an authorized person from government. The work from an unauthorized person cause fire or electric shock.
 -  Place this unit securely on a stable surface. Serious damage and/or injury may result if the unit falls.
 - Do not set up this unit near the leaking place because it may expose you to dangerous voltages or other risks.
 - Even if your product is water proof, do not install it slanted place of water leakage, which can a short circuit.
 - Fix the product on the wall safely according to the installation guideline to prevent any damage or injury.
 - The disconnect device shall remain readily operable.
-
- The work of distributing wires needs skills and experiences. So please, for assistance, contact your dealer or call service center.
 - The communication wire should be built in being distant from the power source.
 -  This may result in the risk of fire, electric shock and communication disorder.
 - Setting the communication wire in a high humid place such as outside without any protection from rain causes the communication disorder.
 - Keep the hook at the wall-mounted device safe. The hook may cause the physical injury.
 - Think about the thickness and quality of wall material. The unqualified material may make the device fall.
-
-  Set the device of the wall-mounted type not to fall. Falling from an earthquake causes personal injury.

Cautions for Repairs and Maintenance

-  Keep the inside of the device clean. Having the dust inside without any cleaning for a long time causes the fire. If necessary, contact your dealer or service center to get cleaning service.
 - Unplug this device when you want to check the inside. If there is no plug, please, turn off the circuit breaker.
 -  Unplug this device when you try to move it to another place.
 - If the electric line is connected inside of the unit, please contact your dealer or service center.
-
-  Do not use liquid or aerosol cleaners. Use a damp cloth for cleaning.

Warning

Warnings for Usage

- Do not install this unit near the water and dust, for example, in a bathroom or near the washing machine. It caused fire and electric shock.
 - Do not install this unit near the fire, for example, near kitchen sink, heater or the like.
 - Do not install near the noxious gas such as Hydrogen Sulfide, metal powder and the like.
 - Do not install near the water and chemicals.
 - Do not give any damage, break and modify the plug. Overloading, heating, pulling causes the damage.
 -  Do not place the plug near the heater. The damaged code causes fire and electric shock. Do not pull the power code when unplugging.
 - The damaged code causes fire and electric shock. Must pull with plug. Do not touch with wet hands. It causes the electric shock.
 - Do not use any other voltage, except the marked regular voltage.
 - Do not use the power terminal at the units to other electric device except the designed device.
 - Do not install the units at the leaking place if it doesn't have any waterproof mark. Do not install the unit when the power is on.
 - Install the circuit breaker after checking the safety such as electric shock and leakage. Turn off the power before you install or A/S
-
- Check the suitability of the wire for installing when you use the exiting wire.
 - Do the wiring work by using the designed material.
 -  Connect the electric wire with the designed ways and ground.
 - Do not connect with any other devices except the designed devices to compose the system.
-
-  Unplug electric wire and communication wire from the units before relocate the product.

ⓘ Cautions for Use

- This unit is not designed for security purpose.
- Do not handle the unit with the wet hands.
- Do not place a pot with water or a small metal material on the Units.
- Do not cover the ventilating opening or put any metal material in the units.
- During thunderstorms, avoid using this unit. There may be a remote risk of an electric shock from lightning.
- Any changes or modifications to the equipment not expressly approved by the party responsible for compliance could void user's authority to operate the equipment.



- Do not disassemble the back and cabinet cover.

ⓘ Cautions for Abnormality

- Change the damaged electric code.
- Unplug this unit from plug socket and refer servicing to an authorized service center when the following conditions occur:
 - If liquid has been spilled into the unit.
 - If the unit does not work normally by following the operating instructions.
 - If the unit exhibits a distinct change in performance.
 - If the unit has been dropped or physically damaged.



Caution

ⓘ Safety Instructions, Warnings and Cautions of Each System

- Do not disassemble this unit as will as this device is composed by precision parts.
- Do not touch or insert any foreign substances, for example, sticker, magnetic, opener and the like.
- Make U-type at the end of wires as the rain can effect on the system by following the wires during the rainy season.
- Install the unit by following the set-up instructions of Kocom.

ⓘ Videophone

- Separate the AC/DC wire with the hook of the wall-mounted type when installing.
- Do not distribute signal line with AC line.
- Do not clean the LCD with the damp cloth for cleaning. Use the only dry and soft cloth.
- Connect the wire after peeling the wires properly.
- Use the designed driver to connect the wire to terminal.
- Do not install the main gate monitor at the leaking place.

ⓘ Things You Need to Know

- This product is designed as a home videophone and cannot use continuously like monitor camera.
- If there is temperature difference between inner part of camera and surrounding, dew condensation occurs on camera lens and may disturb image. If dew condensation is removed from camera lens, image quality recovers.
- White LED light examination range is narrower than camera shot range at night, so there is less amount of light at night than day. So it is difficult to see the face in low illumination condition due to noise increase on screen, but it is not from defect.
- Monitor screen (liquid crystal panel) is not in defect when some pixels always light or black out.
- Please install monitor and camera over 5cm away.
- Also, avoid installing at a place with too much noise, because too much noise around camera causes phone call inferiority.
- Do not place an object within 20cm in front of monitor. It causes phone call inferiority, especially because microphone is installed at the top of monitor.
- If strong light such as sunlight flows into camera module, screen saturation (or strange mark) and image shaking might occur.
- This is not a defect, so please do not install camera where a direct ray of light do not flow if possible.

ⓘ Cautions

- In some cases there is occurrence of product destruction, malfunction, noise mixing and picture quality deterioration due to mixing of other tool's induced, voltage or thunder with communication wiring of monitor/camera, monitor/extended monitor.
- Do not wire with power line such as outdoor wiring or AC power, or phones and other tools.
- You cannot use it if you incorrectly wire the AC voltage between monitor/camera, monitor/extended monitor.
- Call the store or agency where you purchased this product and consult to solve the problem.
- Beware that unfixable damage might be caused due to authorizing AC voltage on communication wiring of monitor/camera, monitor/extended monitor.
- Do not ever disjoint this product. It may cause electrocution accident when touching high-voltage circuit inside this product.
- Outside power authorizing this product must be confirmed of product description and use rated voltage.
- Beware that if higher voltage is authorized, unfixable damage might be caused due to product destruction.
- Power must be connected to domestic voltage (product rated voltage) consent or interior wiring.
- If connected to other motive power or inverter-type power, product destruction, noise mixing, and picture distortion may occur.
- Do not drop this product. Glass is used for monitor and might break, or cause other circuit inferiority.
- In such case, immediately turn down the power switch, and call to consult agency or store in which this product was purchased.
- Keep away from any conditions where water splatters or falls. Do not place anything containing water like a vase on the product.
- If you install a product nearby an antenna used for broadcast media, image could be distorted or mixed with a voice so that it is likely not to work properly in some functions.
- Avoid installing near tools with strong electromagnetic waves such as microwaves and cell phones, as it may cause a picture distorted or a voice with a noise. In that case, the product is likely not to work properly in some functions.
- Do not install monitor in following places.
 - ① Above or around water heater, rice-cooker, heater
 - ② Place exposed to direct rays of the sun
 - ③ Place with temperature below 0°C such as cold store
 - ④ Place with high humidity such as bathroom, washroom, heated room
 - ⑤ Place with a lot of gas, dust, smoke
 - ⑥ Dangerous place with sprays of water or chemicals
- Do not wipe with insecticide, drugs or chemicals such as thinner and alcohol, or it may damage the surface of this product.
- Beware of occurrence of image quality deterioration or malfunction from cause of humidity due to penetration of chemicals or water into camera's urea resins.
- As in the picture, it prevents temperature difference of camera (outside) and monitor (inside), and removes dew condensation caused by humidity of camera window.
- Camera must be installed when wall cement is completely dry.
- When product is installed in winter below -5°C, wait for approximately 2 hours to connect. Dew formation in monitor and camera due to temperature difference inside and outside may cause product defect.
- Avoid installing monitor and camera in place directly exposed to heat or where gas noxiousness is highly occurring.

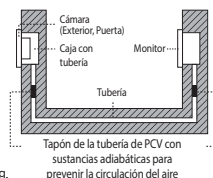

Installation location

■ Monitor installation location

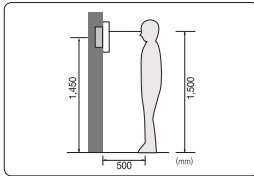

Recommended installation height is about 1,500mm where screen center is at eye level. In this case, wall-hanging metal center (center of piping) is 1,450mm above ground level.

■ Camera installation location

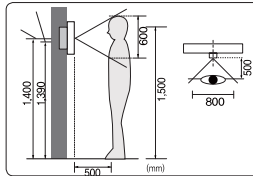

Recommended installation height of door camera is where lens is about 1,400mm above the floor. In this case, camera stack center (Buried box) is above 1,390mm above ground level.

■ Caution of camera installation

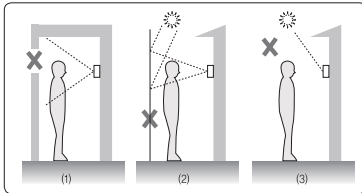

- Avoid installing camera exposed to direct sunlight or lights.
- Back light or shadow on visitor's face may occur difficult recognition.
- Avoid installing camera in places such as the following picture.
 - (1) Place illuminating sky as background
 - (2) Place with white wall reflecting direct ray of light
 - (3) Place with direct ray of light

■ Monitor installation

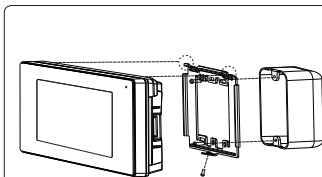

■ Directly connecting cut-off power cord with power wire

- 1) Personal electrical work must be avoided. Please find local installer or electrician for installation.
- 2) power cords must be insulated with insulation tape after the work.
[Exposed wires may cause fire or electric shock.]
- 3) Highly recommend to cut main power supply off before electrical work.

- 1) Remove metal wall hanger bracket behind monitor.
- 2) Install metal wall hanger bracket on 1 type box or wall with attached screw.
- 3) Connect wiring to monitor back terminal referring to product connection diagram.
- 4) Hang monitor on metal wall hanger bracket, and fix monitor on metal wall hanger bracket using attached screw.
- 5) Test the product status if the monitor is both plugged in and switched on.

■ Door camera installation

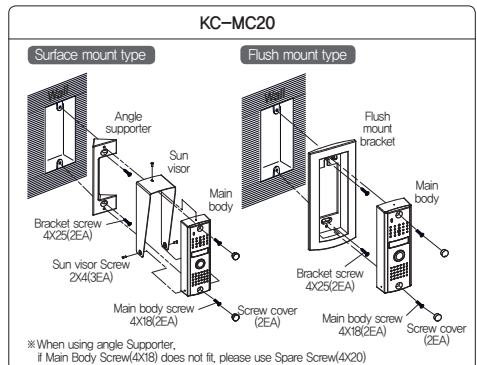
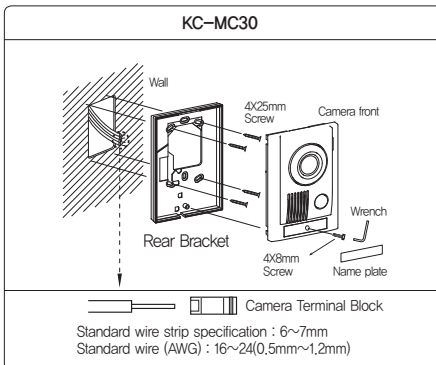
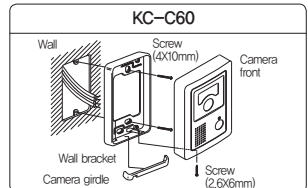
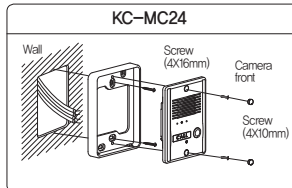
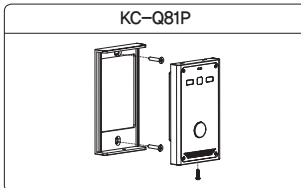

※ After fix the rear bracket with 4 screw, put the Door Camera into the grooves of rear bracket, and then fix it with hexagon screws and stick the finishing materials.

Components of product

■ Monitor



■ Wall hanger



■ Wire



4Pin cable camera x 2ea

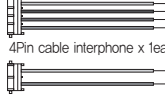

4Pin cable interphone x 1ea

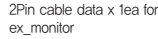

2Pin cable data x 1ea for ex_monitor



4Pin cable CCTV x 1ea



Option
2Pin cable monitor door x 1ea

■ Screws



4X25mm 4ea
3X8mm 1ea

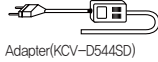

Adapter(KCV-D544SD)



Micro SD card (Option)

■ Door Camera

[KC-Q81P]



[Option]



Bracket



Sun visor



Finishing rubber



Screws for fixing camera main body supporter
4X10mm

■ Door Camera

[KC-C60]

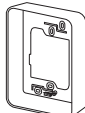

Bracket



4X10mm



2.6X6mm



Wall to bracket Screws

Camera to bracket screw

camera girdle for adjust lens angle

[KC-MC24]



Bracket



Finishing rubber



Screws for fixing camera main body supporter
4X10mm



Screw for fixing camera
4X16mm

[KC-MC30]



Bracket



4X25mm



4X8mm



Wall to bracket Screws

Camera to bracket screw

"L" wrench screw cover (KC-MB30)

[KC-MC20]

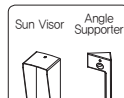

Sun Visor Angle Supporter



Flush Mount Bracket

Screws Cover (2EA)

Sun Visor Screw (2X4mm 3EA)

Bracket Screw (4X25mm 2EA)

Main Body Screw (4X18mm 2EA)

※ In case of Surface mount type, 'Sun Visor' and 'Angle Supporter' are packed together with the 'product'. Flush mount type includes 'flush mount bracket'.

Specifications

Monitor	Model No.	KCV-544SD		KCV-D544SD		
	Power Source	100~240V~, 50/60Hz		DC 15V-2A		
	Power Consumption	5W(±20%)(Stand by), 12W(±20%)(In load)		5W(±20%)(Stand by), 12W(±20%)(In load)		
	Operating Temperature	0°C ~ +40°C				
	LCD	7 inch LCD				
	Communication Type	HandsFree Type				
	Wiring	Door camera : Polarized 4 wire Interphone : Polarized 4 wire Ex-Monitor data : Polarized 2 wire CCTV : Polarized 2 wire				
	Mount Type	Surface mount				
	CCTV Type	Analog HD Type (TVI, CVI, AHD), (720p , 1080p)				
	Memory Type	Micro SD card SDHC 32GB (SDXC 128GB max)				
Dimension	223(W) X 130(H) X 33(D) mm					
Door Camera	Model No.	KC-Q81P	KC-MC30	KC-MC24	KC-C60	KC-MC20
	Power Source	DC 12±1V(Power from Monitor)				
	Power Consumption	Max. 3W				
	Operating temperature	-10°C ~ +50°C				
	Dimension(mm)	75(W) x 136.5(H) x 18.5(D)	110(W) x 158(H) x 39(D)	96(W) x 127(H) x 32(D)	95(W) x 127(H) x 34(D)	40(W) x 120(H) x 22(D)
	Viewing angle	Diagonal 90° (angle adjustable)	Diagonal 100° (angle adjustable)	Diagonal 90°	Diagonal 100°	Diagonal 90°

※ Door Camera Wiring : Polarized 4 wire[VCC(12V) / GND / AUDIO / VIDEO]

※ Recommend adaptor : CT-140200 (13.6V) / JPW123ka1502N05(15V)

※ Kocom doesn't have responsible of non verified power supply.

Name and Functions of each part

■ Monitor part

· Front

· Left side

· Right side

· Back

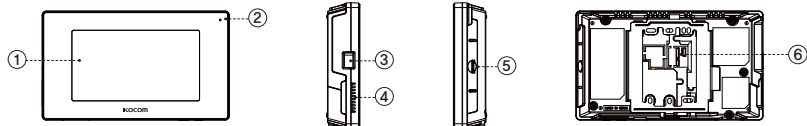

① 7" Touch LCD Monitor

② Microphone

③ AC Power Switch

④ Speaker

⑤ Micro SD card socket

⑥ Terminal : Ports for door camera, CCTV, interphone, EX_monitor

■ Camera part

· Front

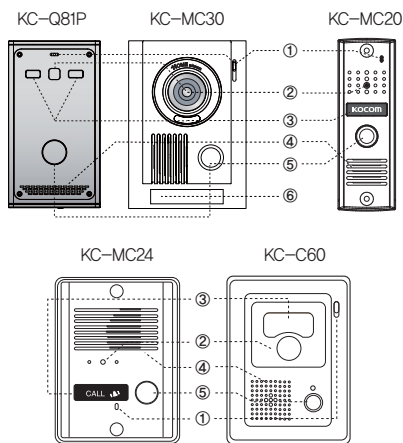

① C-Mic : To communicate with Monitor

② Camera Lens

③ LED

④ Speaker

⑤ Call Button : Calls resident

⑥ Nameplate

· Back

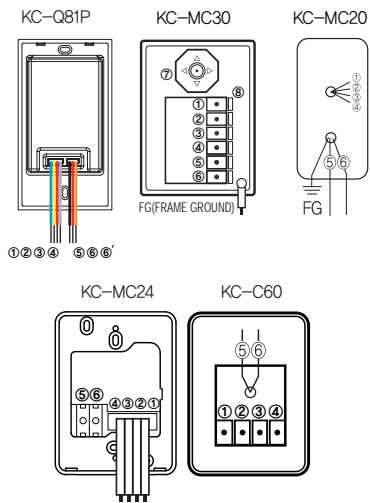

① VCC

② GND

③ Audio

④ Video

⑤&⑥ Door (Non-Polarity)

⑦ Camera angle knob

(Only KC-MC/MC30)

⑧ Wire clamp

Product Wiring diagram

■ Camera & CCTV mode Diagram

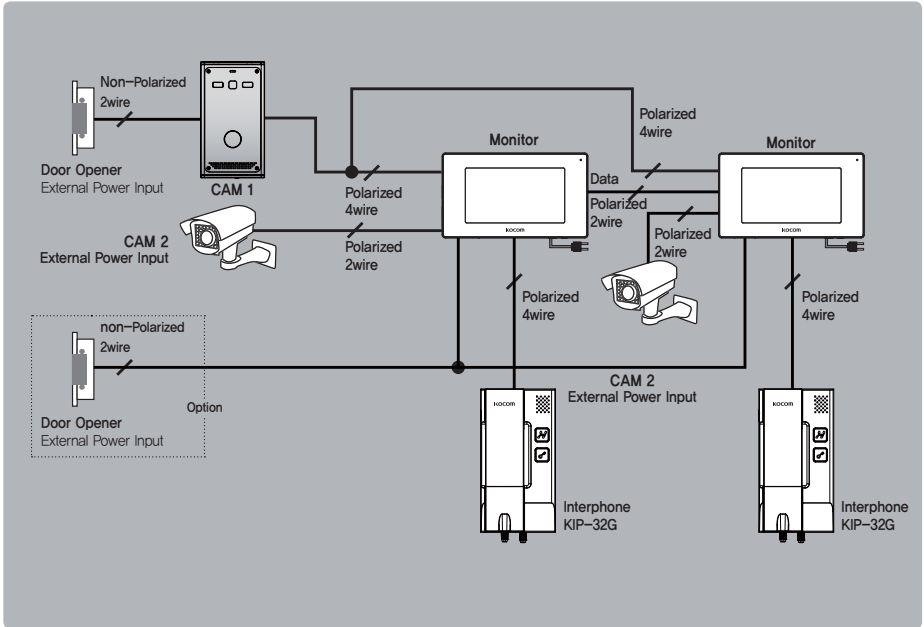

■ Camera mode diagram

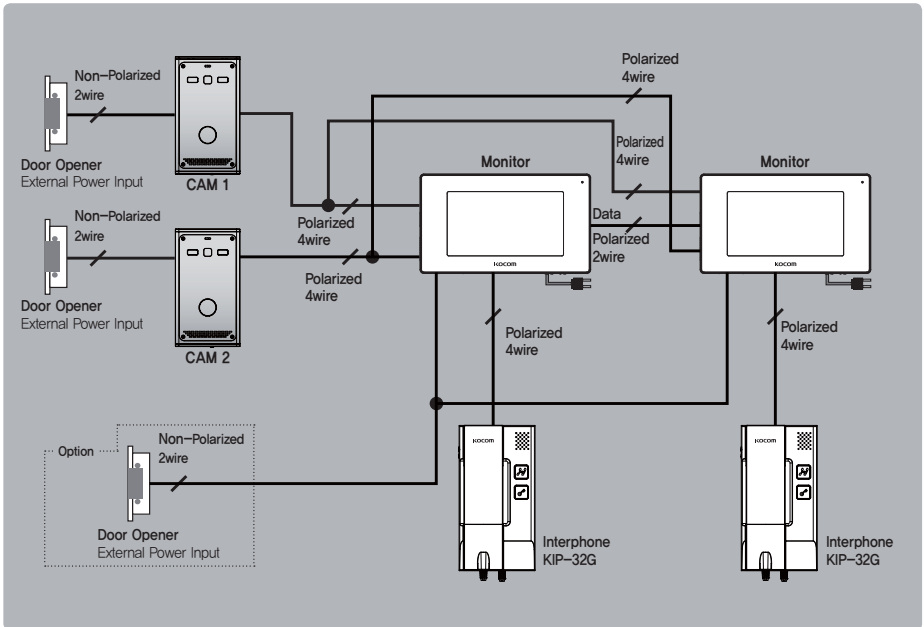

Product Wiring diagram

System mode diagram

※ KLP-420 SYSTEM must be connected to CAM1 port of the monitor

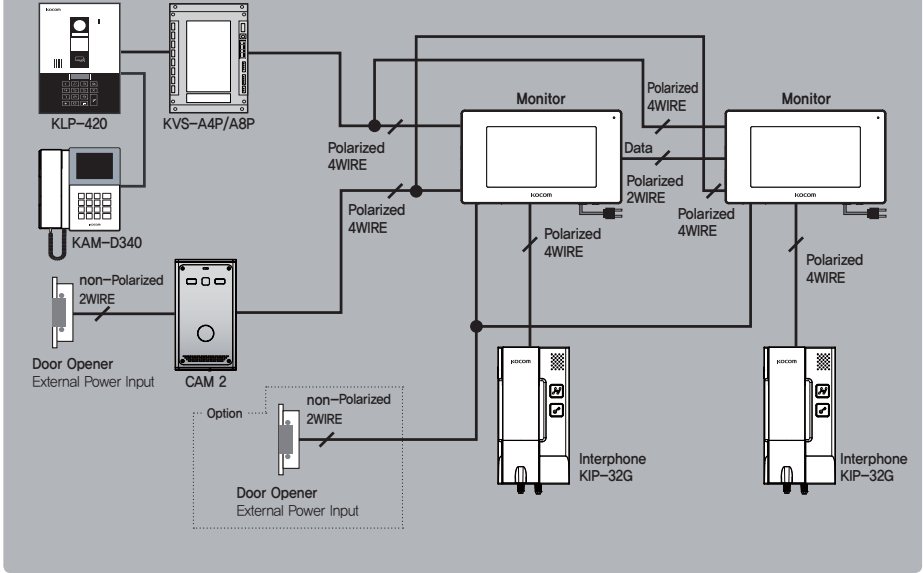

Terminal

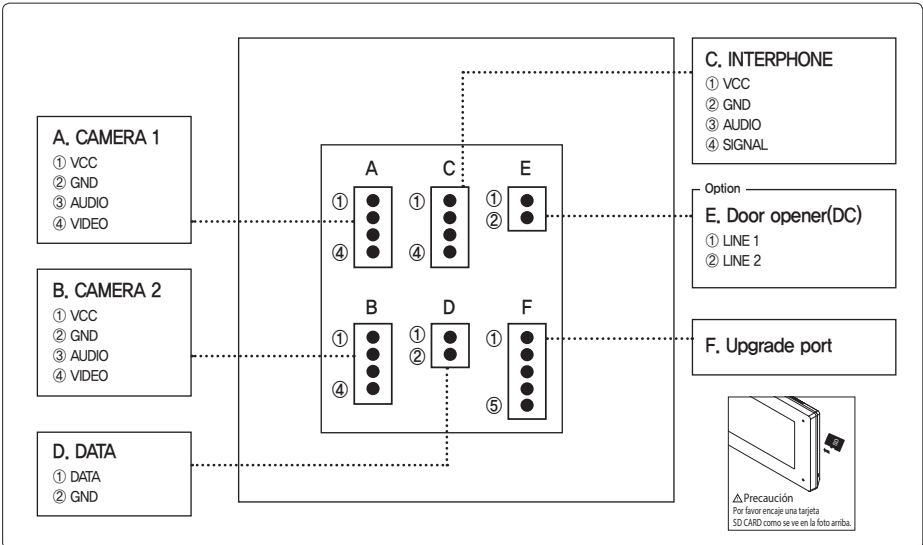

Product wiring diagram

■ Cable requirement – Based on distance from a camera to the monitor

– Upto 100M : CAT5 cable

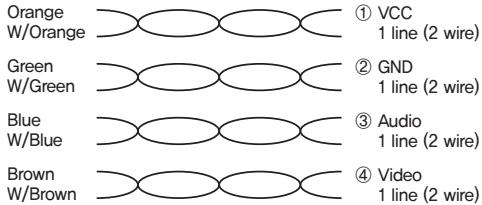

※ CAT5 wire configuration

※ More than 50 meters of distance may cause quality failure. Recommended wire specification as follow;

– Upto 50m : TIV 0,65mm² cable

– Upto 100m : Over TIV 0,8mm² cable

– Upto 150m : TIV 0,8mm² cable + RG-59 / U
RG-59 / U (Coaxial cable) for Video signal
(Connect core to Video & shield to GND)

※ Apart from product malfunction, installed environment may cause failure of video quality.
Optimal distance from camera to monitor is about 50 meters.

■ CCTV Camera connection (CAM2 Port)

– Please obtain CCTV camera power on its own.

– Only compatible with Analog HD CCTV camera.

– Use Coaxial Cable for CCTV connection.

– Using UTP Cable might lead to lower video resolution or no video output.

– Upon initial monitoring, video trembling may occur due to automatic video recognition.

Monitor Terminal(CAM2)

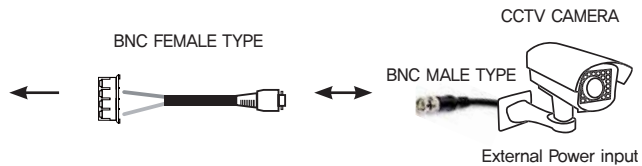
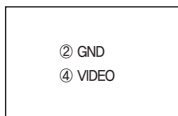

■ Compatibility with Micro SD card

– SDHC 32GB 10CLASS or better, SDXC 128GB (MAX) 10CLASS or better

– You may face malfunctioning or inability to save video if you do not use SD card that is provided by our company.

– Please use SD card by periodically formatting in on PC.

– When using SD card that has been used in another device, make sure to use it after formatting it on PC.









Operation Manual

Using Micro SD card

- Micro SD card is used to save recorded video or to run e-Album.
- Micro SD card should be formatted periodically.
- Using Micro SD card that is not vouched by our Company may prevent the product from functioning properly.
- Make sure to turn off the power when inserting or removing Micro SD card.
- If Micro SD card is inserted or removed while the product is in operation, data saved in the data might be lost, or critical malfunction may occur on Micro SD card.
- Make sure to conduct periodical backup on important videos saved in Micro SD card.
- Recovery may be difficult if error occurs on Micro SD card.

Location for saving files in Micro SD card

- When booting is completed after inserting Micro SD card in the product, folder required for product operation will automatically be created in Micro SD card.
- Folders in Micro SD card

-  album : Files used for e-Album are saved here (Supported file type - *. jpg)
-  capture
 -  cctv : Files captured from CCTV screen are saved here (Supported file type - *. jpg)
 -  door : Files captured from door camera are saved here (Supported file type - *. jpg)
-  music : BGM (background music) used for e-Album are saved here (Supported file type - *. mp3)
-  upgrade : Upgrade programs are saved here
-  video
 -  cctv : CCTV video recordings are saved here (Supported file type - *. mp4)
 -  door : Door camera recordings are saved here (Supported file type - *. mp4)

Using a CCTV Camera

- Among Analog HD type of CCTV, HD(720p) and FHD(1080p) resolutions are supported.
- Power for CCTV needs to be supplied separately.
- Some CCTV may not be compatible.
- Set resolution of CCTV according to the type of CCTV.
- Video resolution may be reduced according to type of Coaxial cable.

Turning on power

- Press power switch on the left side of the product to boot the product.
- Booting logo will show up once booting starts.
- Booting is completed in about 1 minute once all icons are shown on the Home screen.



Home screen

- Home screen is the start screen where all functions of the product can be run.
- Press menu icon in Home screen to run desired functions.



Home screen UI

- ① Display SD card information



No or unrecognizable SD card.



Capacity of SD card in %

- ② Display newly recorded files :



Displays videos of unconfirmed visitors and number of motion recordings

- ③ Display automatic recording (Icon On/Off) :



Indicates that automatic recording is ON for door calling.
(How to configure: Home screen > Setting > Videophone > Auto-Recording)

- ④ Icon for moving to gallery screen



Check or delete visitor recordings and capture screens in gallery
Run e-Album in gallery

- ⑤ Icon for monitoring Door camera 1



- ⑥ Icon for calling security office :



When configuring CAM 1 setting as the system, Door 1 camera monitoring icon is automatically changed to icon for calling security office.
(How to configure: Home screen > Setting > System > Cam1)

- ⑦ Icon for monitoring CCTV



- ⑧ Icon for monitoring Door camera 2 :



When configuring CAM 2 setting as door camera, CCTV monitoring icon is automatically changed to CAM2 door camera monitoring icon.
(How to configure: Home screen > Setting > System > CAM2)

- ⑨ Icon for Calling inter-house



Enable Intercom in setting to automatically create the icon.
(How to configure: Home screen > Setting > VIDEOPHONE > INTERCOM)

- ⑩ Icon for setting screen



Configure various settings for using the product.
Make sure to check configured values in setting before using the product.

- ⑪ Quick menu icon :



Quick menu can be registered in Gallery screen.
Refer to gallery screen manual on registering menus.
Refer to quick menu manual on using quick menu.

★ SD card UNMOUNT FUNCTION

: If you press SD card information icon in Home screen, SD card will be unmounted.

Home screen – Quick menu

Press quick menu to move to relevant screen without going through sub-menus.
Register frequently used gallery menu or file as quick menu to use them conveniently.

Using quick menu



Press 'View quick menu' in Home screen.



Once registered quick menu shows up, press quick menu icon.



Move to registered screen.

Deleting quick menu



Press 'View quick menu' in Home screen.



Press quick menu for 2 seconds.



Press delete button on the top of quick menu icon to delete quick menu.

How to register quick menu :

Register in gallery screen. Refer to 'How to register quick menu in gallery.'

About quick menu: Displayed in icons as below according to types of the quick menu.



e-Album
file list



e-Album
file



Door capture
file list



CCTV capture
file list



Capture file



Door video
file list



CCTV video
file list



Video file

Home UI – Quick menu (if no quick menu is registered)

If no quick menu has been registered,
following message will pop up when Pressing quick menu button in Home screen.

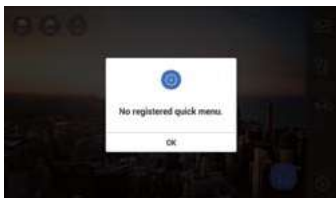

About call screen icon (basic screen)



① About status indication button



- ① **A** Door camera 1 **B** Door camera 2
- ② This indicates the status of operating
Call is in progress. Press to connect talk.
Talk is in progress. Press to end talk.
Door is open.
Monitoring status is on. Press to start or end monitoring.
- ③ Displays remaining time. (Unit: seconds)

② Record video Button : Records video displayed on screen.

- : Recording is off. Press to start recording.
- : Recording is on. Press to end recording.

③ Capture screen button : Capture video shown on screen.

- ④ Start call button
- End call button
- ⑤ Open door button : Shown while call is on. Press to open door.

Saving screen video

Videorecord visitor video screen or CCTV screen.
Voices are recorded when talk is in progress.



Press 'Record video' icon



'Record video' icon is displayed on the top.
Press 'Record' during recording to
end recording.



Capturing screen

Capture visitor video screen or CCTV screen.



While the screen is seen,
Press 'Capture' to capture the screen with capture sound.

- Video files and capture files are saved in micro SD card.
- File storage location

- capture
 - cctv : CCTV screen capture file (File type - *. jpg)
 - door : Door camera capture file (File type - *. jpg)
- video
 - cctv : CCTV video recording file (File type - *. mp4)
 - door : Door camera video recording file (File type - *. mp4)

Setting door screen



Swipe up from the bottom to view the menu bar.



Select menu and then swipe side to side to change the value.



Swipe down from the top to disappear the menu bar.



Swipe right to disappear the function bar.

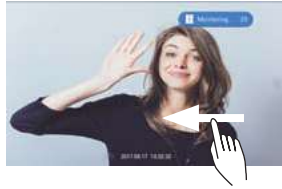

Swipe left to view the function bar.



Setting menus for door camera screen

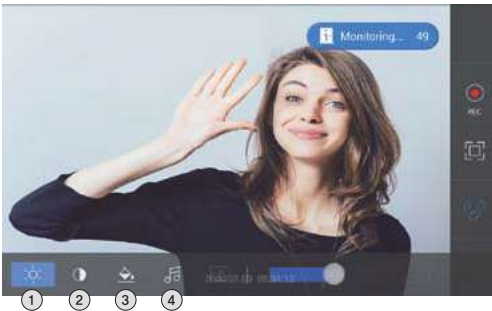

- ① Adjust video brightness
- ② Adjust video contrast
- ③ Adjust video color
- ④ Adjust call volume (shows on monitoring/call screen)
Changes into talk volume if talk is on.
- ⑤ Adjust video screen size : 640x480, 925x600, 1024x600
- ⑥ Adjust setting value

Entering Talk when called by door camera

Video record visitor video screen or CCTV screen.
Voices are recorded when talk is in progress.



Press the call button to make a call



Door call will sound and visitor video will show up on the monitor. Press Status indication or Start call button to connect the call. (Call standby time: 30 sec)



While Talk is on, Press Status indication or End call button to end the call. (Call time : 3 min)



Press Door open button while Talk is on to open the door. Talk will Automatically end after the Door is opened. (Time for opening door: 1~10 sec) (Time for opening door: Can be changed in setting)

Monitoring door camera



Press door monitoring button at Home button to monitor door screen.

- Door 1 monitoring button
- Door 2 monitoring button



Press Status indication button on door 1 monitoring screen to end monitoring (Monitoring time : 1 min—can be changed in setting)



Press Status indication button on door 1 monitoring screen to start monitor Door 2



Press Call button during monitoring to connect Talk with the door.

Calling with additional phone



Press extension call button in Home screen to call the extension of the connected additional phone.

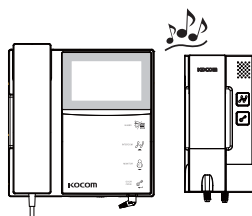

Extension call will sound on the additional phone.
(Call waiting time: 30 sec)

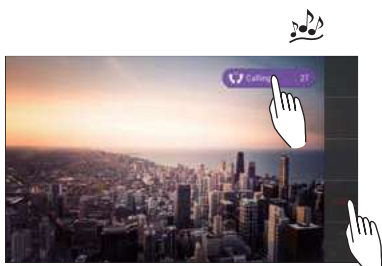

Screen will move to extension call screen.
Connect call from the additional phone.
Press Status indication or End call button on extension call screen to cancel the call.

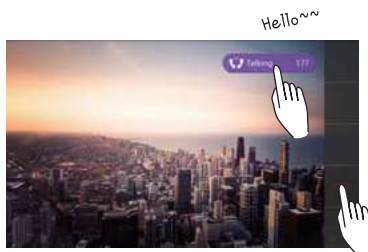

Press Status indication or End call button on the screen during Talk to end Talk.

※ Caution

1. To use extension, turn on the intercom at Setting > Videophone.
2. Extension call is possible only if the additional phone is on Standby.

Talking when called by additional phone

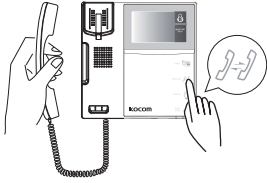

When calling extension using additional phone,

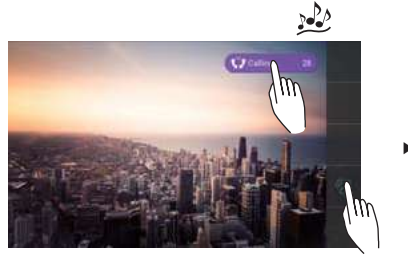

Extension call will sound, and the screen will move to extension call Screen. Press Status indication or Start call button to connect the call with additional phone.

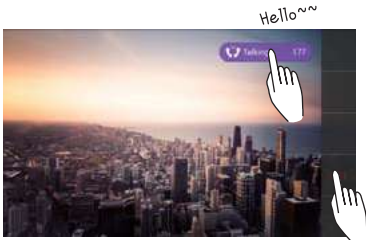

Press Status indication or End call button on the call screen to end the Talk.

Connecting call when called by lobby phone

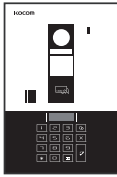

Call a household on lobby phone.



Lobby call will sound on the monitor,
and visitor video will show.
Press Status indication or Start call button to
connect the call.
(Call waiting time: 30 sec)

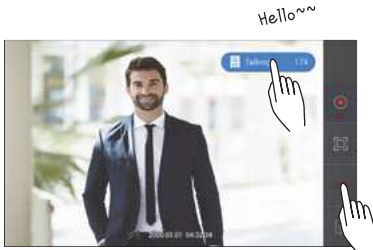

During Talk, Press Status indication or End call
button to end the call.
(Call time: 3 min)



During Talk, Press Open Door
button to open the door.
(Door opening time: 1~10 sec)
(Door opening time: can be changed in setting)

※ Caution

1. To use security/lobby function, go to
Setting > Videophone and set cam1 as 420System.
2. To use security/lobby function, you need to link 420System.

Talking by calling security office phone



On the home screen, Press Status indication or End call button to cancel the call.

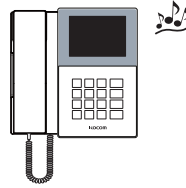

Call will sound on security office phone.
(Call waiting time: 30 sec)

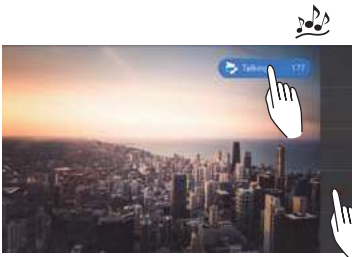

Screen will move to security phone screen, When the security office connects the call, call will be connected with the office.
On the call screen with security office, press Status indication or End call button to end the call.

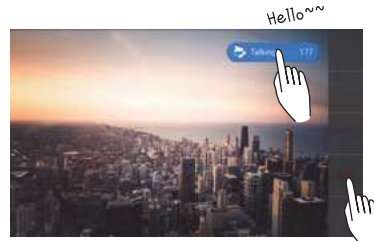

During Talk with security office phone, press Status indication button to end the Talk.

Talking when called by security office phone

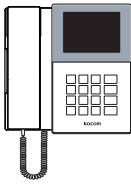

When called by security office phone,



Security call will sound and the screen will move to security call screen. On security call screen, Press Status indication or Start call button to connect the call with security office.

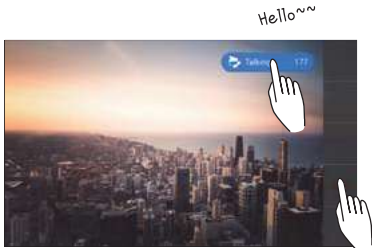

During Talk, Press Status indication or End call button to cancel the call.

Displaying screens related to extension call

■ Additional phone and door camera are in a call



If extension interphone or additional phone is in use, busy-line status will show as follows.

In this case, the monitor cannot call or connect Talk. Normal use will be enabled once busy-line status ends.

■ Screens related to extension call



Interphone and Door 1 are in a call



Interphone and Door 2 are in a call



Interphone and security office are in a call



Interphone and lobby are in a call



Additional phone and Door camera 1 are in a call



Additional phone and Door camera 2 are in a call



Additional phone and security office are in a call



Additional phone and lobby are in a call



Additional phone and interphone are in a call



Additional phone and additional phone are in a call

CCTV screen icons



Icons on Basic screen

- ① Move to home screen
- ② Start/end video recording
- ③ Capture image
- ④ CCTV setting
: Press to show setting information
- ⑤ Remaining space of SD card
- ⑥ CCTV resolution: Configure in system setting
- ⑦ Motion recording: Configure in system setting

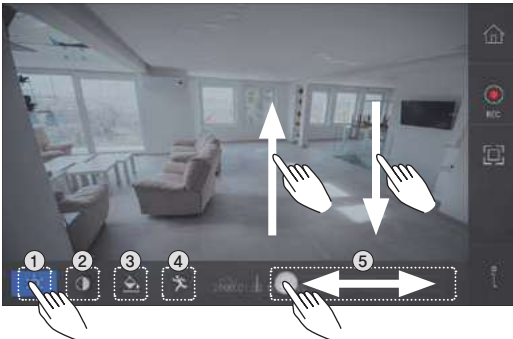

1. Swipe up from the bottom to view the menu bar.
2. Press setting menu buttons in ①~④ and use the slide bar on ⑤ to change values.
3. Swipe down from the top to disappear the menu bar.

Screen setting menus

- ① Adjust video brightness
- ② Adjust video contrast
- ③ Adjust video color
- ④ Select motion sensitivity

View CCTV screen



Press CCTV monitoring button on Home screen to move to CCTV monitoring screen.



Press Home button to move to Home screen.
(Monitoring time: 3 min – Can be changed in setting)

※ Setting CCTV resolution

: Configure with resolution same as CCTV at Setting > CCTV > RESOLUTION. (720p – HD, 1080p – FHD)

Recording when CCTV camera detects motion

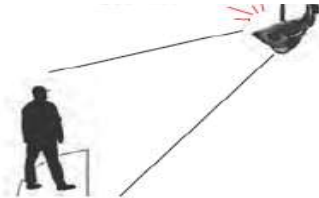

Motion recording starts when motion is detected on CCTV video.



CCTV screen will be displayed and automatic recording will begin.
Screen will be recorded for 1 minute.

※ Setting CCTV resolution

: Configure with resolution same as CCTV at Setting > CCTV > RESOLUTION. (720p – HD, 1080p – FHD)

※ Caution

1. To enable motion recording, turn on MOTION at Setting > CCTV.
2. Motion detection recording will run only on CCTV monitoring screen of standby mode (while LCD screen is off).
3. If recording begins even though there is no motion (due to video noise) lower motion sensitivity on Screen setting > Motion sensitivity on CCTV monitoring screen. Be aware that motion detection might not work if motion sensitivity is too low.

Viewing saved video files



Press Gallery button on Home screen to move to Gallery screen.



Press Video button to show sub-menu.



Select DOOR or CCTV to move to the list of saved files.



Search files by swiping the screen up and down.



Press the file to be played in play screen.

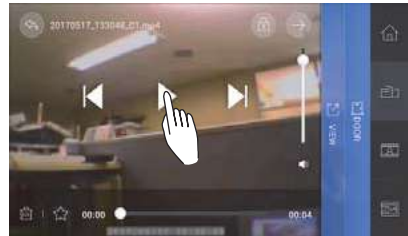

Press to play.

Viewing saved capture files



Press Gallery button on Home screen to move to gallery screen.



Press capture button to show sub-menu.

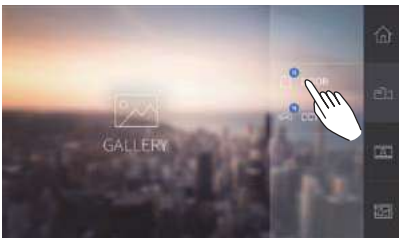

Select DOOR or CCTV to move to the list of saved files.



Search files by swiping the screen up and down.

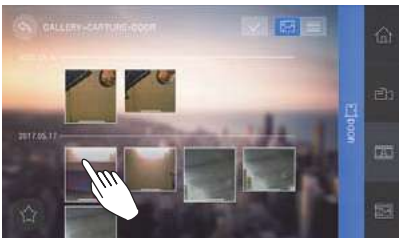

Press the file to be played in play screen.



View selected file in full size.

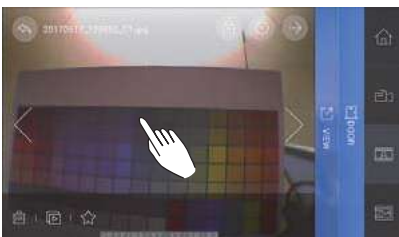

Press the screen to show capture screen menu.

Gallery screen



Icons

- ① Home screen: Move to home screen
- ② View video sub-menu
- ③ View capture sub-menu
- ④ e-Album: Move to e-Album screen

Gallery sub-menu screen

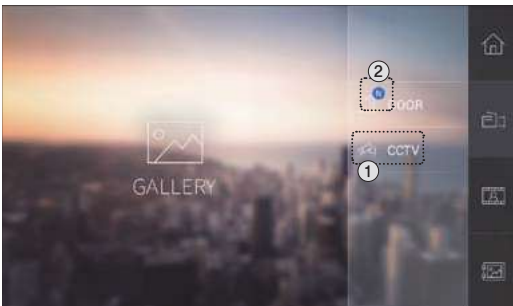

Icons

- ① Video and capture sub-menus show DOOR and CCTV sub-menus.
- ② Missed recording files and unchecked motion recording files are marked 'New'.

Gallery – Video/Capture – File list screen

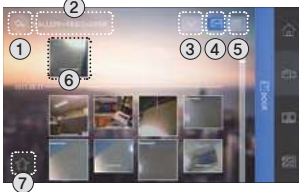

Image list screen



Delete file screen



Text list screen

Icons

- ① Return to previous screen
- ② Current menu
- ③ Expand delete menu (@ : icon for select all , @ : icon for recycle bin)
: press the button, press related files, and press recycle bin to delete selected files.
: press Select All to select all files, and press the recycle bin to delete all files.
- ④ Convert to Image list
- ⑤ Convert to Text list
- ⑥ Thumbnail screen
New & Lock are displayed (LOCK can be set in file play screen.)
Locked files cannot be deleted.
- ⑦ Register quick menu
: File list screen is registered as quick menu.

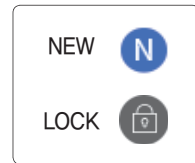

Gallery – Video/Capture – File play screen

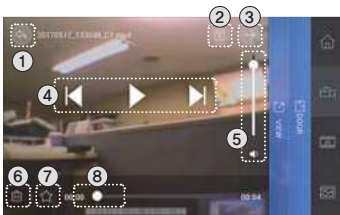

Video play screen

- ① Move to previous screen
- ② Lock file
- ③ Full screen
- ④ Previous file/(Play/Pause)/Next file
- ⑤ Adjust volume
- ⑥ Delete file
- ⑦ Register file as quick menu
- ⑧ Display and move video time

Setting menu closes 5 seconds after file play begins.
Press the screen to re-open setting menu.



View capture file

- ① Move to previous screen
- ② Lock file
- ③ SETTING: Change slide setting value
(Refer to the page on e-Album slide setting)
- ④ Previous file/Next file
- ⑤ Delete current file
- ⑥ Start Slider Show
- ⑦ File favorites
- ⑧ Full screen

Running e-Album



Press gallery button on Home screen to move to gallery screen.



Press e-Album button on Gallery screen to move to e-Album file list.



Swiping the screen up and down on file list screen to search files.



Select file to move to the screen of running e-Album.



Selected file will run in full screen.
Press the screen to show e-Album menu.

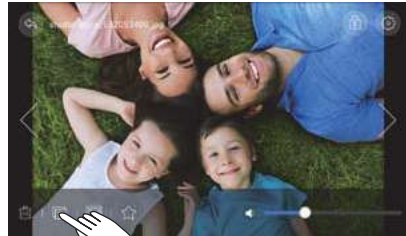

Press Slide Show button to run slide show.

Gallery – e-Album – View file list screen



Image list screen



Text list screen

Icons

- ① Move to previous screen.
- ② Current menu
- ③ Expand delete menu
 - : Press the button, press related files, and press recycle bin to delete selected files.
 - Press Select All to select all files, and press the recycle bin to delete all files.

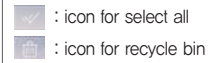

- ④ Convert to Image list
- ⑤ Convert to Text list
- ⑥ Thumbnail screen
 - New & Lock are displayed
 - (LOCK can be set in file play screen.
 - Locked files cannot be deleted.
 - Register quick menu
 - : File list screen is registered as quick menu.

Gallery – e-Album – Slide show setting screen



Image list screen



Text list screen

Image Viewer screen

- ① Move to previous screen
- ② Lock file
- ③ Slide show setting
- ④ View previous / next file
- ⑤ Delete current file
- ⑥ Start Slider Show
- ⑦ Set as background
- ⑧ File favorites
- ⑨ Adjust BGM volume

Slide show setting screen

- ① Close setting
- ② View slide show option
- ③ BGM ON / OFF button
 - (When BGM is ON, mp3 file in Sd card Music folder is played)
- ④ Detailed file information

Gallery – Capture – Slide show setting screen



SLIDE SHOW options

- ① Close SLIDE SHOW option
(Moves to SETTING screen)
- ② Duration of each slide show page: 3/5/10 sec
- ③ Duration of entire Slide Show
30 min/1 hr, Moves to main screen after completion.
- ④ Choose Slide Show effects

Gallery – POP UP screen



If there is no SD card, no SD card screen pops up when Gallery is pressed in main screen.

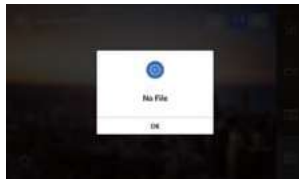

If there is no file in the folder, No File screen pops up. Press OK to move to previous screen.

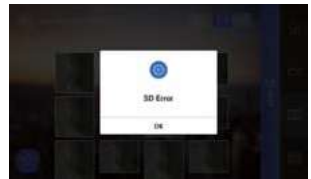

If SD card is removed, SD card error screen pops up. Press OK to move to main screen.

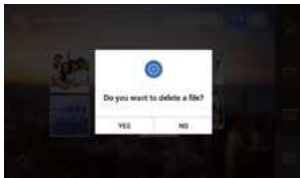

When deleting file in the list, press YES to show the message 'Deleting...' with the progress bar. press NO to move to previous screen.

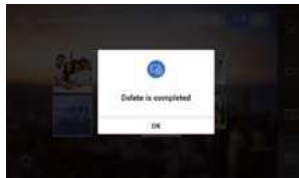

Displayed when deletion is complete.

System setting screen

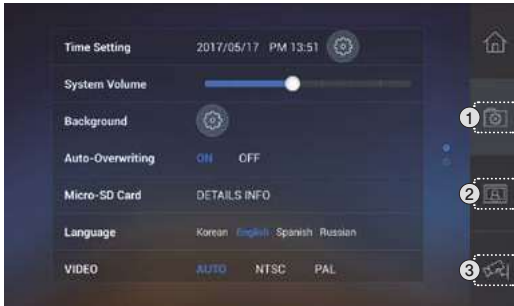

1. Press Setting on Home UI screen to move to system setting screen, System setting can be changed.

System setting menu screen

- ① System setting menu
- ② Video phone setting menu
- ③ CCTV setting menu

System setting menu

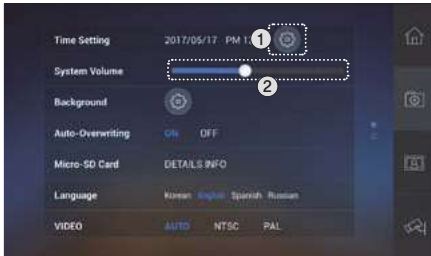

- ① Time setting button
- ② System volume bar



Time setting screen

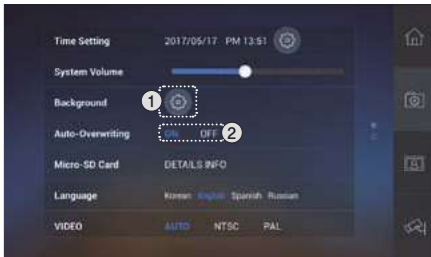

- ① Background setting button
- ② Automatic recording On/Off

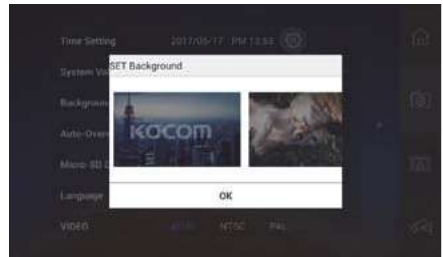

Background setting screen

System setting screen



- ① SD card information
- ② Language setting
- ③ Video NTSC/PAL setting

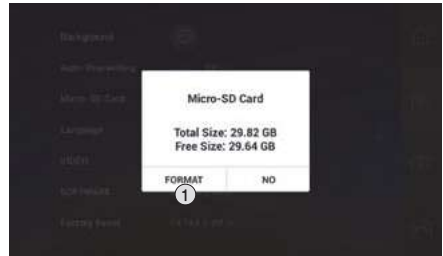

- SD card information screen
- ① Press FORMAT to format SD card.



- ① Software information



- Software information can be checked here.
- ① Copy Upgrade SW to Upgrade folder of SD card and Press UPGRADE to upgrade.

System setting menu



① Factory reset



Factory reset screen

- ① Press RESET to initialize all configuration values to the status of factory shipment.

Video phone setting screen

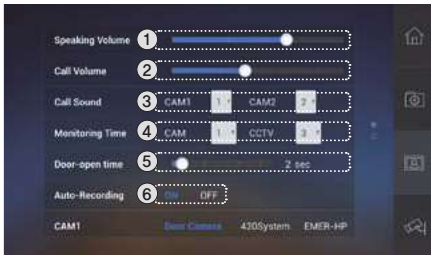

- ① Talk volume bar
 ② Call volume bar
 ③ Call sound setting tab: Change call sound (1~6)
 ④ Monitoring time setting
 CAM : 1,3,5 min
 CCTV : 3 , 30 ,60 min
 ⑤ Door-open time adjustment bar: 1~10 sec
 ⑥ Setting on automatic recording



- ① Camera Port 1 button
 ▶ Security office button will show in Home screen when setting 420 System.
 ② Camera Port 2 button
 ▶ Select Door Camera to show Door CAM 2 monitoring button on Home screen.
 ③ Door camera selection
 ▶ Video value is optimally set according to camera model. (Caution : Set KC-C60 to MC30.)
 ④ Intercom setting On/Off
 ▶ Press ON to show extension call button on Home screen.

CCTV setting screen



- ① Configure CCTV resolution
- ② Configure CCTV recording frame
- ③ Configure CCTV motion recording

Warranty

④ To receive after service, have the following ready before you contact our branches.

1. Name of the product.
2. Model number of the product.
3. The area of problem.
4. Phone number and address at which you can be contacted.

Warranty Card

PRODUCT	
MODEL	KCV-544SD/D544SD
DATE PURCHASED	
WARRANTY PERIOD	
AGENCY ADDRESS	

④ KOCOM Warranties the original purchaser of this product as follows.

- 1) This product is produced under strict quality control and inspection procedures.
- 2) If this product breaks down during proper use as a result of product defect, KOCOM will repair it within one year from date of purchase free of charge.
- 3) The following cases will be subject to charge, even during warranty period:
 - a. Breakdown during transport, or through careless treatment, by consumer.
 - b. Breakdown cause by unauthorized repair, or system modification.
 - c. Breakdown caused by natural disaster or power disorder.

④ Note: This equipment has been tested and found to comply with the limits for a Class B digital device, pursuant to part 15 of the FCC Rules. These limits are designed to provide reasonable protection against harmful interference in a residential installation. This equipment generates, uses and can radiate radio frequency energy and, if not installed and used in accordance with the instructions, may cause harmful interference to radio communications. However, there is no guarantee that interference will not occur in a particular installation. If this equipment does cause harmful interference to radio or television reception, which can be determined by turning the equipment off and on, the user is encouraged to try to correct the interference by one or more of the following measures:

- Reorient or relocate the receiving antenna.
- Increase the separation between the equipment and receiver.
- Connect the equipment into an outlet on a circuit different from that to which the receiver is connected.
- Consult the dealer or an experienced radio/TV technician for help.



www.kocom.com
E-mail : export@kocom.com

This manual is based on the date as shown in the right and specifications are subject to change without notice for quality improvement

KCV-544SD/D544SD

S0322